

ODYSSEY[®] BATTERY

ENGINEERED WITH THIN PLATE PURE LEAD (TPPL) TECHNOLOGY

OWNER'S MANUAL



www.odyssebattery.com

Powered by **EnerSys[®]**

Power/Full Solutions

INTRODUCTION

The ODYSSEY® battery ingeniously uses Absorbed Glass Mat (AGM) technology to offer, in one box, the characteristics of two separate batteries. It can deep cycle as well as provide enormous cranking power – it is almost as if a champion long distance runner and a world class sprinter are one and the same person.

These batteries are capable of providing engine cranking pulses in excess of 2250A for five seconds as well as 400 charge/discharge cycles to 80% Depth of Discharge (DOD). A typical Starting, Lighting and Ignition (SLI) battery can do one or the other, but not both. It is either a sprinter or a long distance runner; ODYSSEY batteries will do both – provide short duration high amperage pulse or low rate long duration drains.

In order to achieve the full design cycle life of ODYSSEY batteries in cyclic applications the charge current must be a **minimum of 40% of the battery's 10-hour rating (column 8 of the chart on page 7)**. Thus the minimum charge current for a PC925 battery in a cycling application is 10.8 amps (40% of 27Ah). Please refer to Figure 6 of the ODYSSEY battery Technical Manual for a detailed discussion of the recommended charge profile for ODYSSEY batteries in cycling applications, and refer to Table 5 for suggested charge times. The manual may be downloaded from www.odysseybattery.com.

Any data, descriptions or specifications set forth herein are subject to change without notice. Before using the product(s), the user is advised and cautioned to make its own determination and assessment of the suitability of the product(s) for the specific use in question and is further advised against relying on the information contained herein as it may relate to any general use or indistinct application. It is the ultimate responsibility of the user to ensure that the product is suited and the information is applicable to the user's specific application. The product(s) featured herein will be used under conditions beyond the manufacturer's control and therefore all warranties, either express or implied, concerning the fitness or suitability of such product(s) for any particular use or in any specific application, are disclaimed. The user expressly assumes all risk and liability, whether based in contract, tort or otherwise, in connection with the use of the information contained herein or the product itself.

WHY USE ODYSSEY® BATTERIES?

GUARANTEED LONGER SERVICE LIFE

With an eight to 12 year design life (float) and a three to 10 year service life, ODYSSEY batteries save you time and money because you do not have to replace the battery as often. Since actual warranty can vary with your geographical location, please check with your ODYSSEY battery representative for the warranty specific to your application.

SUPERIOR CRANKING AND FAST CHARGE CAPABILITY

The five second cranking power of ODYSSEY batteries is double to triple that of equally sized conventional batteries, even when the temperature is as low as -40°F (-40°C). Also, with simple constant voltage charging (alternator or independent charger), there is no limitation on the inrush current, so the user is assured of fast charge recovery.

MOUNTING FLEXIBILITY

The ODYSSEY battery may be installed in any orientation (except inverted) without sacrificing any performance attributes. Acid spillage is avoided due to the fact that the electrolyte is fully absorbed in the AGM material, and is not free to spill as it is in traditional flooded batteries. The valve regulated design of the ODYSSEY battery eliminates the need for an acid vent tube; eliminating the fear of acid burns or damage to expensive chrome or paint.

SUPERIOR VIBRATION RESISTANCE

ODYSSEY® batteries have endured rigorous tests that demonstrate their overall ruggedness and exceptional tolerance of mechanical abuse.

READY OUT OF THE BOX

ODYSSEY batteries are shipped fully charged. If the ODYSSEY battery's voltage is 12.65V or greater, simply install the battery in your vehicle and you are ready to go! If below 12.65V, boost charge following the instructions in the ODYSSEY battery Owner's Manual and/or Technical Manual. Putting a boost on the battery will not damage it, even if its voltage reads higher than 12.65V.

WORRY-FREE SHIPPING

Owing to the drycell design, the US Department of Transportation (USDOT) has classified the ODYSSEY battery as a nonspillable, so it may be shipped worry-free by express service or by air. Please see our SDS for complete details at www.odysseybattery.com.

LONGER STORAGE LIFE

Unlike conventional batteries that require a recharge every six to 12 weeks, the ODYSSEY battery can be stored for up to two years at 77°F (25°C) from a fully charged state. These batteries can be stored for two years or until the open circuit voltage (OCV) drops to 12.00V, whichever comes first.

DEEP DISCHARGE RECOVERY

Should the ODYSSEY battery become deeply discharged, simply recharge following instructions in this manual.

INSTALLATION

Your ODYSSEY battery is normally ready to install right out of the box! Measure the battery voltage; if it is 12.65V or greater, install; if less, then refer to the charging section.

ANY OF THE FOLLOWING WILL VOID THE WARRANTY ON YOUR ODYSSEY® BATTERY:

- REMOVING THE LABELED COVER
- REMOVING OR DESTROYING THE BATTERY'S DATE CODE

ODYSSEY EXTREME SERIES™ BATTERY WARNING – DO NOT USE ANY TYPE OF OIL, ORGANIC SOLVENT, ALCOHOL, DETERGENT, STRONG ACIDS, STRONG ALKALIS, PETROLEUM-BASED SOLVENT OR AMMONIA SOLUTION TO CLEAN THE BATTERY COVERS AND BATTERY TOPS. THESE MATERIALS MAY CAUSE PERMANENT DAMAGE TO THE BATTERY COVERS AND BATTERY TOPS AND WILL VOID THE WARRANTY.

ODYSSEY PERFORMANCE SERIES™ BATTERY WARNING – PROLONGED EXPOSURE AND OR IMMERSION INTO ANY TYPE OF OIL, ORGANIC SOLVENT, ALCOHOL, DETERGENT, STRONG ACIDS, STRONG ALKALIS, PETROLEUM-BASED SOLVENT OR AMMONIA SOLUTION TO CLEAN THE BATTERY COVERS AND BATTERY TOPS MAY CAUSE PERMANENT DAMAGE TO THE BATTERY COVERS AND BATTERY TOPS AND WILL VOID THE WARRANTY.

DO NOT SHORT CIRCUIT YOUR ODYSSEY® BATTERY'S TERMINALS!
Remove any metallic items such as watches, bracelets and other personal jewelry to ensure safe installation.

For FAQs and troubleshooting, please refer to www.odysseybattery.com.

ODYSSEY® EXTREME SERIES™ BATTERIES

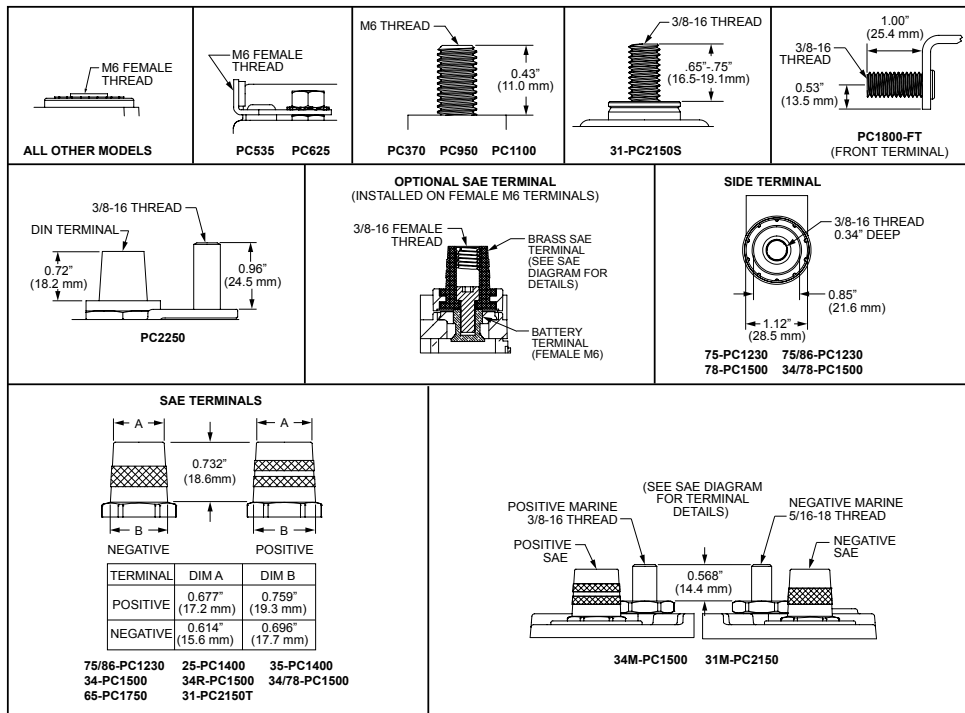

INSTALLATION

- Using proper procedures as recommended by the vehicle manufacturer, carefully disconnect the cables from your old battery and remove it from the vehicle. Return the spent battery to the battery dealer for proper recycling.
- Inspect existing battery cables for corrosion, acid damage or insulation deterioration. Replace if deterioration is present.
- Position your ODYSSEY® battery in the battery holder and fasten firmly to the vehicle.
 - Optional height adapter may be used on the Group 34 models for installations where a group 24 or group 27 is required. Snap the adapter securely into place on the bottom of the battery. The Group 34 models with this adapter may be used to replace a group 24F or 27F.
- Connect the positive cable from your ignition to the Positive (+) terminal.
- Connect the negative cable from your engine or chassis to the Negative (-) terminal.
- Torque the bolt, screw or nut per the specification noted in table. If you're using the Accessory Bolt (C), hold the Brass Post (A) with vise grips and counter torque. Do the same with General Motors® automotive battery cable installation.



NOTE: This is a valve regulated sealed battery and never needs to have water or electrolyte (acid) added. Warranty will be void if opened!

ODYSSEY® PERFORMANCE SERIES™ BATTERIES

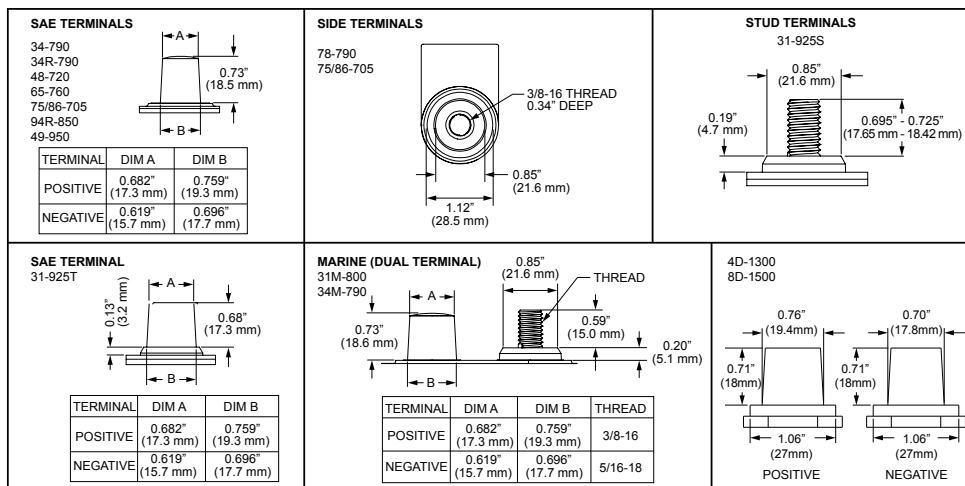

SPECIAL NOTICE!

- CUSTOM V-TWIN MOTORCYCLE INSTALLATIONS USING ODYSSEY PC535, PC545, PC545MJ, PC680MJ AND PC925LMJ BATTERIES**
If your V-Twin motorcycle is equipped with a standard 32 amp single phase stator/ alternator and you ride at a low engine rpm around town or even on long rides, the appropriate ODYSSEY battery may run out of charge due to low amperage output of the bike's stator at low rpms. After riding, turn the bike's engine off but leave the lights on for 30 seconds. Then, turn everything off and connect the ODYSSEY battery charger using the proper procedure as detailed in the ODYSSEY battery charger owner's manual.
- Prolonged storage of vehicles with fuel injection computers, alarms, GPS and other electrical devices that require continuous battery power to support active memories; this power drain must be offset with a maintenance-float charger, periodic charging or disconnecting the battery to prevent the establishment of irreversible crystallized sulphation in the battery plate oxide. Failure to address this destroys battery capacity and voids the warranty, as this is not a warranted defect in materials or workmanship.

ODYSSEY® BATTERY STORAGE AND DEEP DISCHARGE RECOVERY

Figure 1 shows the relationship between Open Circuit Voltage (OCV) and State of Charge (SOC) for the ODYSSEY® battery.

(A) How do I know the state of charge of the battery?

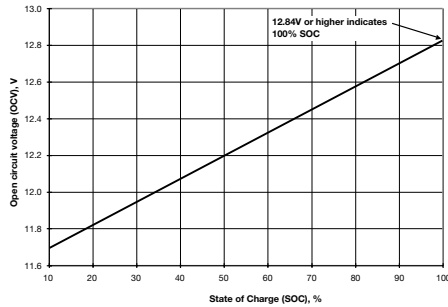

Figure 1: ODYSSEY® battery OCV vs. SOC

As long as the battery has not been charged or discharged for 6 or more hours, Figure 1 can be used to determine the SOC of the ODYSSEY battery. Use a high quality digital voltmeter to measure its OCV. The graph shows that a healthy, fully charged ODYSSEY battery will have an OCV of 12.84V or higher at 77°F (25°C).

(B) How long can the battery be stored?

ODYSSEY batteries should be fully charged prior to storage. Fully charged ODYSSEY batteries can be stored for up to 24 months at 77°F (25°C). Battery voltage naturally decreases with time and with increased temperature. The battery voltage should be checked periodically. If the battery voltage drops to 12.0 volts (35% SOC) it should be recharged immediately to avoid permanent battery damage. The following can be used as a rough approximation for the potential storage times at different temperatures.

Storage Temperature	Storage Time (Months)
41°F (5°C)	48
59°F (15°C)	36
77°F (25°C)	24
95°F (35°C)	12
113°F (45°C)	6

Figure 2: ODYSSEY® battery storage time at temperatures

ODYSSEY® EXTREME SERIES™ BATTERIES

Model	Voltage	PHCA** (5 sec)	CCA*	HCA	MCA	Nominal Capacity		Reserve Capacity Minutes	Length inches (mm)	Width inches (mm)	Height inches (mm)	Weight lbs (kg)	Terminal	Torque Specs in-lbs (Nm-max)	Internal Resistance (mΩ)	Short Circuit Current
						(20 Hr Rate-Ah)	(10 Hr Rate-Ah)									
PC310	12	310	100	200	155	8	7	9	5.43 (138.0)	3.39 (86.0)	3.90 (99.0)	5.9 (2.7)	M4 Receptacle	8.9 (1.0)	27.1	455A
PC370	12	425	200	315	270	15	14	25	7.9 (200.0)	3.0 (77.0)	5.5 (140.0)	12.5 (5.7)	M6 Stud	35 (3.9)	13.5	891A
PC535	12	535	200	300	265	14	13	21	6.70 (170.2)	3.90 (99.1)	6.24 (158.5)	12.0 (5.4)	M6 Receptacle	40 (4.5)	7.1	1000A
PC545	12	460	150	280	220	13	12	18	7.01 (178.1)	3.38 (85.9)	5.16 (131.1)	11.4 (5.2)	M6 Receptacle	50 (5.6)	7.8	800A
PC625	12	540	220	400	330	18	17	26	6.70 (170.2)	3.90 (99.1)	6.95 (176.5)	13.2 (6.0)	M6 Receptacle	40 (4.5)	7	1800A
PC680	12	520	170	350	280	16	16	24	7.27 (184.7)	3.11 (79.0)	7.55 (191.8)†	15.4 (7.0)	M6 Receptacle† or SAE 3/8-16" Receptacle	50 (5.6)	7.5	1000A
PC925	12	900	330	610	480	28	27	48	6.64 (168.7)	7.05 (179.1)	5.83 (148.1)†	23.8 (10.8)	M6 Receptacle† or SAE 3/8-16" Receptacle	60 (6.8)	4.3	1140A
PC950	12	950	400	600	500	34	32	60	9.8 (250.0)	3.8 (97.0)	6.1 (156.0)	20.0 (9.0)	M6 Stud	35 (3.9)	7.1	1700A
PC1100	12	1100	500	800	650	45	43	87	9.8 (250.0)	3.8 (97.0)	8.1 (206.0)	27.5 (12.5)	M6 Stud	35 (3.9)	5.1	2450A
PC1200	12	1200	540	860	725	42	40	78	7.87 (199.9)	6.66 (169.1)	7.60 (193.0)†	38.2 (17.4)	M6 Receptacle† or SAE 3/8-16" Receptacle	60 (6.8)	3.2	1500A
75-PC1230	12	1230	760	1050	815	55	50	110	9.47 (240.5)	7.08 (179.8)	7.44 (189.0)	43.4 (19.7)	SIDE 3/8-16" Receptacle	60 (6.8)	2.5	3100A
75/86-PC1230	12	1230	760	1050	815	55	50	110	9.47 (240.5)	7.08 (179.8)	7.98 (202.7)	43.4 (19.7)	TOP SAE SIDE 3/8-16" Receptacle	60 (6.8) Side Terminal Only	2.5	3100A
25-PC1400	12	1400	850	1150	950	65	55	130	9.47 (240.5)	6.85 (174.0)	8.75 (222.3)	50.0 (22.7)	SAE	N/A	2.5	3100A
35-PC1400	12	1400	850	1150	950	65	55	130	9.47 (240.5)	6.85 (174.0)	8.75 (222.3)	50.0 (22.7)	SAE	N/A	2.5	3100A
34-PC1500	12	1500	850	1250	1050	68	62	135	10.86 (275.8)	6.77 (172.0)	7.88 (200.2)	49.5 (22.4)	SAE	N/A	2.5	3100A
34R-PC1500	12	1500	850	1250	1050	68	62	135	10.86 (275.8)	6.77 (172.0)	7.88 (200.2)	49.5 (22.4)	SAE	N/A	2.5	3100A
34M-PC1500	12	1500	850	1250	1050	68	62	135	10.86 (275.8)	6.77 (172.0)	7.95 (201.9)	49.5 (22.4)	SAE and 3/8-16" Stud (Pos.), 5/16-18" Stud (Neg.)	60 (6.8) Stud Only	2.5	3100A
34/78-PC1500	12	1500	850	1250	1050	68	62	135	10.86 (275.8)	7.09 (180.1)	7.88 (200.2)	49.5 (22.4)	TOP SAE SIDE 3/8-16" Receptacle	60 (6.8) Side Terminal Only	2.5	3100A
78-PC1500	12	1500	850	1250	1050	68	62	135	10.86 (275.8)	7.09 (180.1)	7.34 (186.4)	49.5 (22.4)	SIDE 3/8-16" Receptacle	60 (6.8)	2.5	3100A
PC1700	12	1550	810	1325	1175	68	65	142	13.03 (331.0)	6.63 (168.4)	7.78 (197.6)	60.9 (27.6)	M6 Receptacle† or SAE 3/8-16" Receptacle	60 (6.8)	2.2	800A
65-PC1750	12	1750	950	1350	1070	74	65	145	11.84 (300.7)	7.19 (182.6)	7.49 (190.2)	54.0 (24.5)	SAE	N/A	2.0	5000A
PC1800-FT	12	1800	1300	1600	1450	214	190	475	22.87 (581.0)	4.92 (125.0)	12.46 (316.5)	132.3 (60.0)	3/8" Stud	80 (9.0)	3.3	3800A
31-PC2150	12	2150	1150	1545	1370	100	92	205	13.07 (332.0)	6.91 (175.5)	9.70 (246.4)	77.8 (35.3)	3/8-16" Stud or SAE†	200 (22.6) Max Stud Only	2.2	5000A
31R-PC2150	12	2150	1150	1545	1370	100	92	205	13.07 (332.0)	6.91 (175.5)	9.59 (243.6)	77.8 (35.3)	3/8-16" Stud	200 (22.6) For 3/8-16" Stud Only	2.2	5000A
31M-PC2150	12	2150	1150	1545	1370	100	92	205	13.00 (330.2)	6.80 (172.7)	9.39 (238.5)	77.8 (35.3)	SAE and 3/8-16" Stud (Pos.), 5/16-18" Stud (Neg.)	200 (22.6) Max Stud Only	2.2	5000A
PC2250	12	2250	1225	1730	1550	126	114	240	11.26 (286.0)	10.59 (269.0)	9.17 (233.0)	86.0 (39.0)	SAE Terminal and 3/8-16" Stud	100 (11.0) For 3/8-16" Stud Only	2.1	5000A

*Cold Start Performance S.A.E. J537 JUNE 82 **Pulse Current † Can be fitted with brass automotive terminal. Height shown includes SAE post. Optional metal jackets available on PC545, PC680, PC925, PC1200, PC1700 and 31-PC2150. Operating Temperature Range: PC310 and PC1800-FT: -40°F (-40°C) to 122°F (50°C), PC370, PC950 and PC1100: -40°F (-40°C) to 122°F (50°C), PC535 and PC625: -40°F (-40°C) to 113°F (45°C), PC545, PC680, PC925, PC1200 and PC1700 without metal jacket: -40°F (-40°C) to 113°F (45°C), PC545, PC680, PC925, PC1200 and PC1700 with metal jacket: -40°F (-40°C) to 176°F (80°C), PC1220, PC1350 and PC2250: -40°F (-40°C) to 104°F (40°C), All other models: -40°F (-40°C) to 176°F (80°C)

ODYSSEY® PERFORMANCE SERIES™ BATTERIES

Model	Voltage	PHCA** (5 sec)	CCA*	HCA	MCA	Nominal Capacity		Reserve Capacity Minutes	Length inches (mm)	Width inches (mm)	Height inches (mm)	Weight lbs (kg)	Terminal	Torque Specs in-lbs (Nm max)	Internal Resistance (mΩ)	Short Circuit Current
						(20 Hr Rate-Ah)	(10 Hr Rate-Ah)									
75/86-705	12	1100	708	875	760	49	45	89	9.46 (240.3)	7.01 (178.1)	7.98 (202.7)	43.4 (18.7)	SAE, Side 3/8-16" Receptacle	60 (6.8) side only	2.8	2200
96R-600	12	1100	600	800	700	52	48	90	9.51 (241.6)	6.89 (175.0)	6.91 (175.5)	40.3 (18.3)	SAE	N/A	2.8	1740
47-650	12	1150	650	850	750	64	58	105	9.51 (241.6)	6.89 (175.0)	7.49 (190.2)	41.9 (19.0)	SAE	N/A	3.2	1800
48-720	12	1250	723	950	842	69	63	130	10.91 (277.1)	6.89 (174.2)	7.5 (190.5)	48 (21.8)	SAE	N/A	2.8	2300
34-790	12	1500	792	1200	990	61	57	124	10.85 (275.6)	6.78 (172.2)	7.91 (200.9)	46.6 (21.1)	SAE	N/A	2.9	2400
34R-790	12	1500	792	1200	990	61	57	124	10.85 (275.6)	6.78 (172.2)	7.91 (200.9)	46.6 (21.1)	SAE	N/A	2.9	2400
34M-790	12	1500	792	1200	990	61	57	124	10.85 (275.6)	6.78 (172.2)	7.93 (201.4)	47.6 (21.6)	SAE and 3/8-16" Stud (Pos.), 5/16-18" Stud (Neg.)	60 (6.8) studs only	2.9	2400
65-760	12	1500	762	1200	891	64	59	129	11.86 (301.2)	7.19 (182.6)	7.38 (187.5)	49.8 (22.6)	SAE	N/A	2.3	2500
78-790	12	1500	792	1200	990	61	57	124	10.85 (275.6)	7.00 (177.8)	7.4 (188.0)	47.1 (21.4)	Side 3/8-16" Receptacle	60 (6.8)	2.9	2400
31-925	12	1750	925	1325	1150	100	92	200	13.0 (330.2)	6.79 (172.5)	9.44 (239.8)	69.5 (31.5)	3/8-16" Stud	200 (22.6)	2.6	2600
31M-800	12	1600	800	1380	1200	99	94	188	13.0 (330.2)	6.79 (172.5)	9.46 (240.3)	69.3 (31.4)	SAE and 3/8-16" Stud (Pos.), 5/16-18" Stud (Neg.)	60 (6.8) studs only	2.6	2600
94R-850	12	1500	850	1200	1000	80	76	150	12.36 (313.9)	6.85 (174.0)	7.47 (189.7)	54.8 (24.9)	SAE	60 (6.8)	5.7	2250
49-950	12	1700	950	1300	1150	94	85	160	13.87 (352.3)	6.85 (174.0)	7.47 (189.7)	62.8 (28.5)	SAE	60 (6.8)	4.8	2650
4D-1300	12	2400	1300	1747	1549	170	153	370	20.39 (518)	8.78 (223.0)	8.58 (218.0)	117.3 (53.3)	SAE	60 (6.8)	NA	NA
8D-1500	12	2700	1500	2015	1787	220	198	475	20.39 (518)	10.87 (276.0)	8.86 (225.0)	143.0 (65.0)	SAE	60 (6.8)	NA	NA

*Cold Start Performance S.A.E. J537 June 82

** Pulse Current

Operating temperatures from -40°F (-40°C) to 140°F (60°C)

MAINTENANCE

ODYSSEY® batteries are very different from standard flooded batteries that are openly vented. The ODYSSEY battery is and operates as a sealed battery, recycling nearly all gases internally under normal operating conditions. There is no corrosion of the positive terminal or corrosion to the surrounding area. ODYSSEY batteries are shipped fully charged from the factory, but prior to installation, check the battery's voltage to see if it is 12.65V or greater. If not, recharge it using the procedure below.

Do not charge in an air tight compartment.

Never attempt to remove the top decal cover, as it will cause the battery to fail.

CHARGING

The SOC in an ODYSSEY® battery can be determined from the following chart:

Voltmeter Reading	State of Charge
12.84 Volts or higher	100%
12.50 Volts	75%
12.18 Volts	50%
11.88 Volts	25%

To get long life from the ODYSSEY battery, it is important that the battery is kept near full charge, approximately 12.8V. If there are electrical loads during storage, then the negative battery cable should be disconnected or an independent float charger used. Low power 2.0 amp chargers for storage charge will keep a fully charged battery fully charged but cannot recharge if the ODYSSEY battery becomes discharged.

Racing Vehicles using total loss (no alternator) - standard automotive type chargers are not designed to return 105-108% of the energy removed. They normally boost charge to 80-95% and expect the alternator to complete the charge. EnerSys® recommends using approved chargers that provide 105-108% recharge before switching to storage charge. The EnerSys approved chargers are listed on www.odysseybattery.com.

To fully charge a 31-PC2150 and 31-800 battery that is routinely discharged deeply, a minimum of 40 amps are required with charger voltage within the range of 14.1V to 14.7V. It is imperative not to exceed 15.0V as this will cause the pressure valves to open and out-gas hydrogen, oxygen and water from inside the battery. This will shorten the life of the battery and cause premature failure. Some portable chargers exceed 15.0V, especially two-wheel garage chargers, so charging voltages should be verified by measuring the charging voltage during the time when the charging amperage is reducing from full output. The deep cycle charging voltage must be within 14.1V minimum to 14.7V maximum.

If a standard automotive charger is used to boost charge a discharged battery because of an accessory left on, it is important to make sure the charging voltage does not exceed 15 volts during charge. A hand held voltmeter can be used to monitor this periodically.

12V PARALLEL CONNECTION

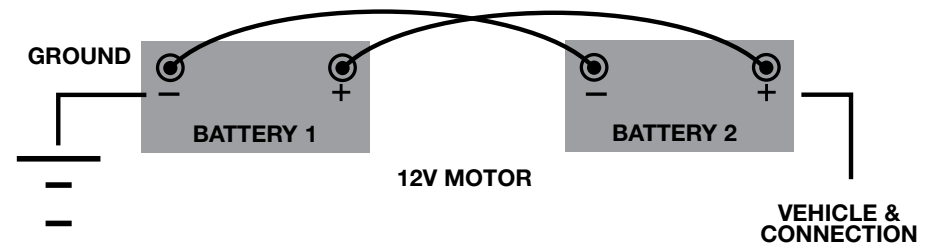

24V BATTERY CONNECTION

To power a 24V trolling motor, you will need to connect two ODYSSEY® batteries in series. As shown in the top illustration, the negative of Battery 1 is wired to the positive of Battery 2. Hook up the positive terminal of Battery 1 to the positive terminal of your trolling motor and the negative terminal of Battery 2 to the negative terminal of the trolling motor.

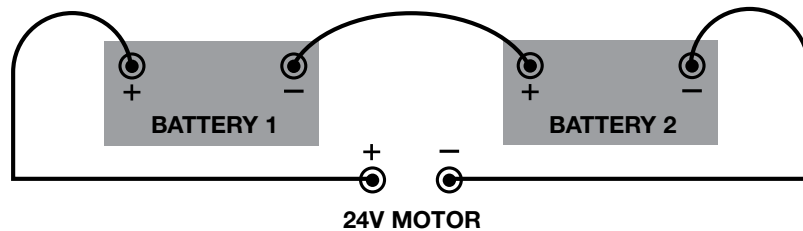

36V BATTERY CONNECTION

To power a 36V trolling motor, you will need to connect three ODYSSEY batteries in series. As shown in the bottom illustration, the negative of Battery 1 is wired to the positive of Battery 2; the negative of Battery 2 is then connected to the positive of Battery 3. Finally, hook up the positive terminal of Battery 1 to the positive terminal of your trolling motor and the negative terminal of Battery 3 to the negative terminal of the trolling motor.

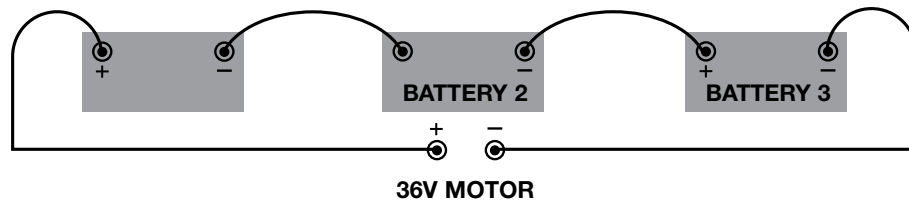

Winter Storage

The ODYSSEY® battery does not lose its charged energy during cold storage temperatures, so there is no need to trickle or float charge during winter months. To store off-season, measure the battery voltage to make sure it is fully charged, 12.84 volts or greater; recharge if necessary. Disconnect the negative battery cable to prevent any applied electrical load during storage. The ODYSSEY battery cannot freeze down to -40°F (-40°C), so it can be left in the vehicle. It can be stored for 2 years or more below 77°F (25°C). Charging is required at 2 years or 12V, whichever comes first.

A 12V, 2 amp trickle charger can also be left connected to the battery if it is kept in storage for extended periods or if the battery is subject to parasitic loads during storage. The trickle charge voltage measured at the battery terminals must be between 13.5V and 13.8V. We recommend using the ODYSSEY battery charger for your battery. Additional information on ODYSSEY battery chargers, where to buy ODYSSEY battery chargers and ODYSSEY battery charging in general can be found on our website at www.odysseybattery.com.

Warranty

For information related to warranty coverage and support, please refer to our General Product Limited Warranty Statement found on our website.

Keep your receipt. Receipt is required for longest Warranty Protection.

For your convenience, this space is provided for attaching your original receipt.

EnerSys World Headquarters
2366 Bernville Road
Reading, PA 19605, USA
Tel: +1-610-208-1991 /
+1-800-538-3627

EnerSys EMEA
EH Europe GmbH
Baarerstrasse 18
6300 Zug, Switzerland

EnerSys Asia
152 Beach Road
#11-08 Gateway East Building
Singapore 189721
Tel: +65 6416 4800

Want more info?
Scan code to access
the ODYSSEY® Battery
Literature Library



Always properly recycle your lead acid battery by returning to an authorized recycling center or automotive dealer.



NEVER PLACE USED BATTERIES IN THE BIN!



www.odysseybattery.com

© 2020 EnerSys. All rights reserved.
Trademarks and logos are the property of EnerSys and its affiliates, except General Motors, which is not the property of EnerSys. Subject to revisions without prior notice. E.&O.E.